

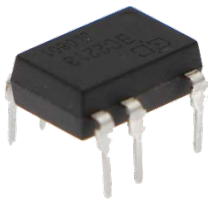

BC5213、BC5223 型光可控硅继电器

产品图片	Features 产品特性	Application 应用	订货示例
 <p>DIP7</p>	<ul style="list-style-type: none"> ● Contact Form 触点形式 1a ● Load Voltage 输出电压 110/220VAC ● Load Current 输出电流 2A ● Operation LED Current 二极管导通电流 50mA MAX ● Load Operation voltage 输出导通电压降 1.3V ● Low Off-State Leakage Current 漏电流 100μA 	<ul style="list-style-type: none"> ● Main business lines domestic appliance 主要适用于家用电器 ● Air-conditioning 空调 ● Washing machine 洗衣机 ● Fridge 电冰箱 ● Intelligent Home 智能家居 	<ul style="list-style-type: none"> ● BC5213 过零型 ● BC5223 随机型
 <p>SMD7</p>			<ul style="list-style-type: none"> ● BC5213A 过零型 ● BC5223A 随机型

Dimensions 外形尺寸

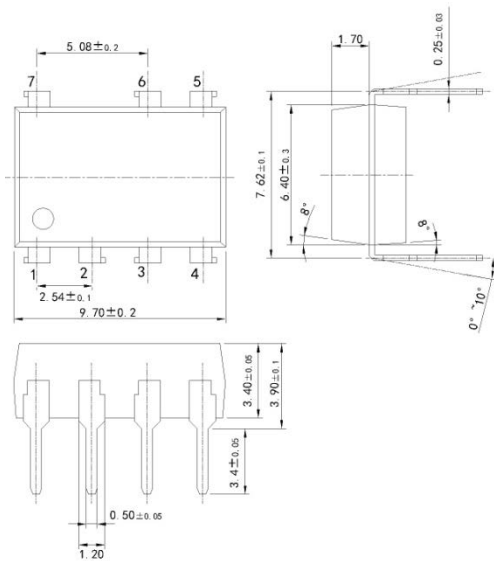

DIP7

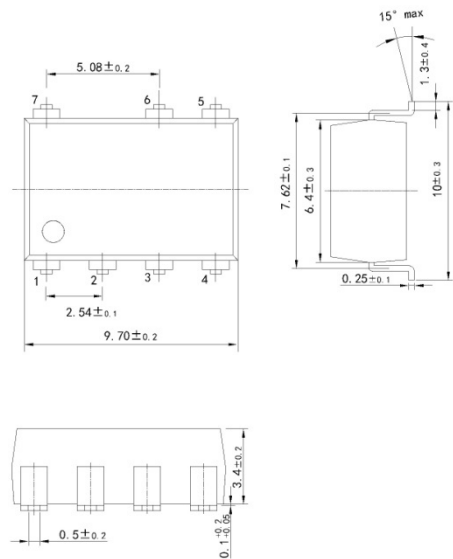

SMD7

Terminal Identification 引脚标识

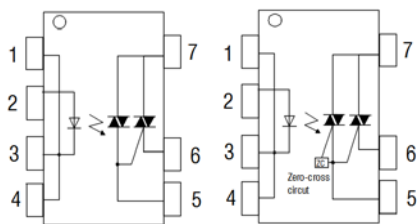

随机性

过零型

Wiring Diagram 接线图

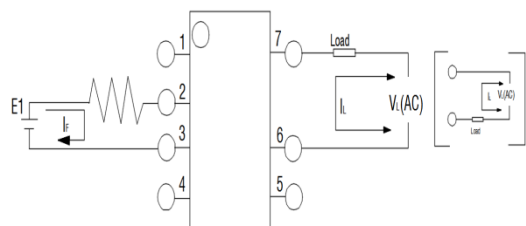

BC5213、BC5223 型光可控硅继电器

Technical parameters 技术参数 (Ambient Temperature 25°C)

I/O Absolute Maximum Ratings 输入输出电气参数最大值

Item 项目		Symbol 符号	Specifications 型号规格		Units 单位
			BC5213 (A)	BC5223 (A)	
Operating Temperature 工作温度		T_{opr}	-30~+85		°C
Storage Temperature 储存温度		T_{stg}	-40~+125		°C
Input 输入	Forward Current 输入电流	I_F	50		mA
	Peak Forward Current 输入电流峰值	I_{FP}	1		A
	Reverse Voltage 输入反向电压	V_R	6		V
Output 输出	Repetitive peak OFF-state voltage 输出瞬态电压	V_{DRM}	600		VDC
	ON-state RMS current 输出电流	$I_{T(RMS)}$	2		A
	Non-repetitive surge current 输出浪涌电流	I_{TSM}	20		A
I/O Breakdown Voltage 输入输出隔离电压		V_{iso}	5000		VAC

Electrical Specifications 输入输出电气参数

Item 项目		Symbol 符号	MIN. 最小值	TYP 典型值		MAX. 最大值	Units 单位	Conditions 条件
				BC5213 (A)	BC5223 (A)			
Input 输入	Forward Voltage 输入电压降	V_F	-	1.18		1.4	V	$I_F=10mA$
	Reverse Current 输入反向电流	I_R	-	-		10	μA	$V_R=5V$
Output 输出	Peak OFF-state current 输出漏电流峰值	I_{DRM}	-	-		100	μA	$V_{DRM}=600V$
	ON-state voltage 输出导通电压降	V_{TM}	-	0.9		2.3	V	$I_T=2.5A$
	Holding current 输出维持电流	I_H	-	-		25	mA	$V_0=6V$
	Rise rate of OFF-state voltage 电压指数上升率	dv/dt	200	1000		-	V/ μS	$V_{DRM}=600V/\sqrt{2}$
Minimum Trigger Current 最小触发电流		I_{FT}	-	2		10	mA	$V_0=6V$
Recovery Input voltage 恢复电压		$V_{F OFF}$	0.5	-		-	V	
I/O Insulation Resistance 绝缘电阻		R_{iso}	50G	-		-	Ω	DC=500V
Turn-On Time 导通时间 (Random-on 随机)		T_{ON}	-	8		100	μS	$I_F=20mA$
Turn-On Time 导通时间 (zero-on 过零)		T_{ON}	-	-		10	mS	-
Turn-Off Time 关断时间		T_{OFF}	-	-		10	mS	-

通讯地址: 深圳市宝安区外贸工业园 6 栋 3 楼

联系人: 蒋生

电 话: 13554924172

BC5213、BC5223 型光可控硅继电器

Reference Data 曲线图

LED forward voltage Vs. Ambient temperature
LED正向电压-环境温度曲线

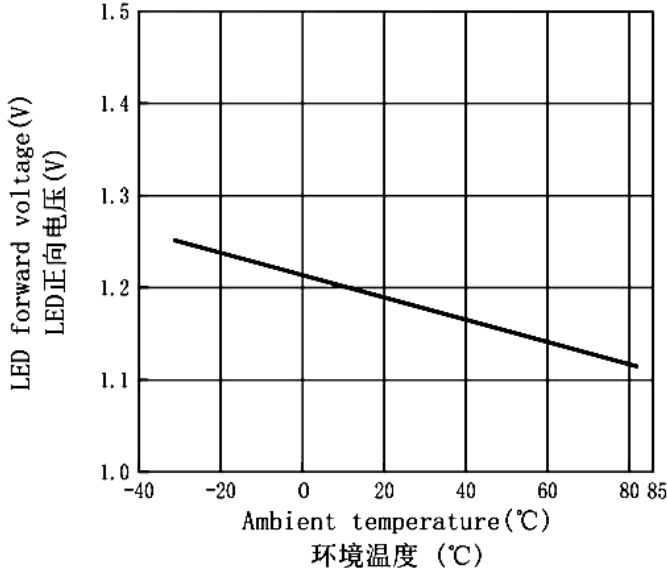

LED operation current Vs. Ambient temperature
LED接通电流-环境温度曲线

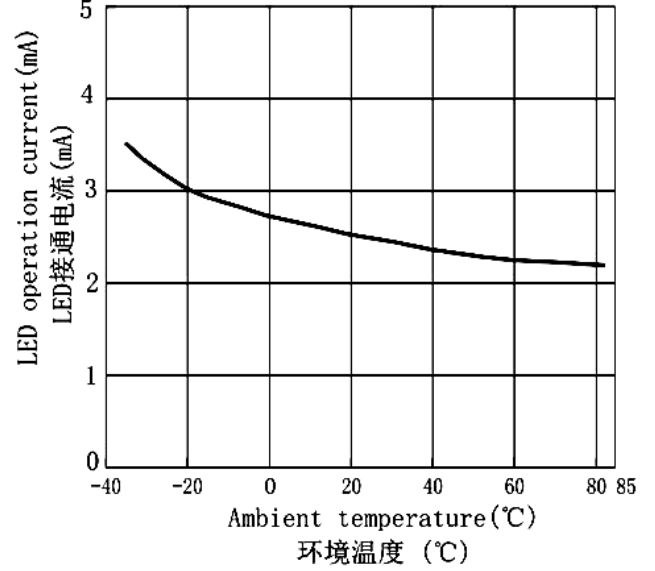

Foward current VS. Foward voltage
输入电流-正向压降曲线

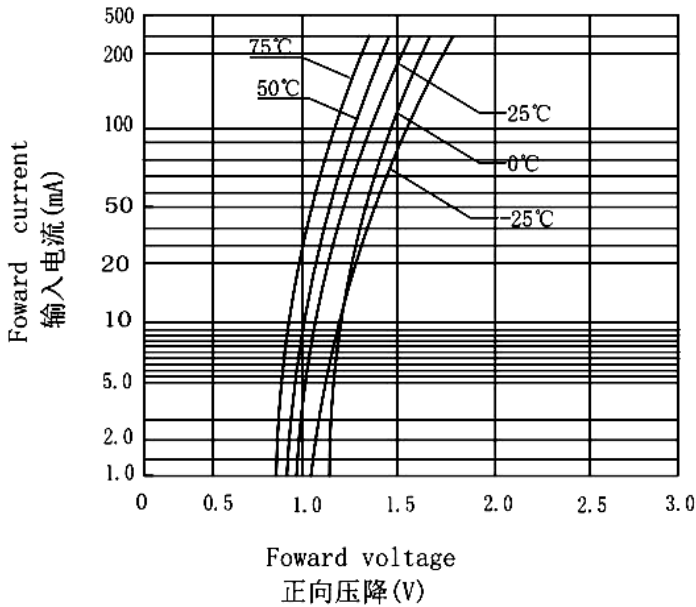

On-state load current VS. On-state voltage drop
输出电流-导通电压降曲线

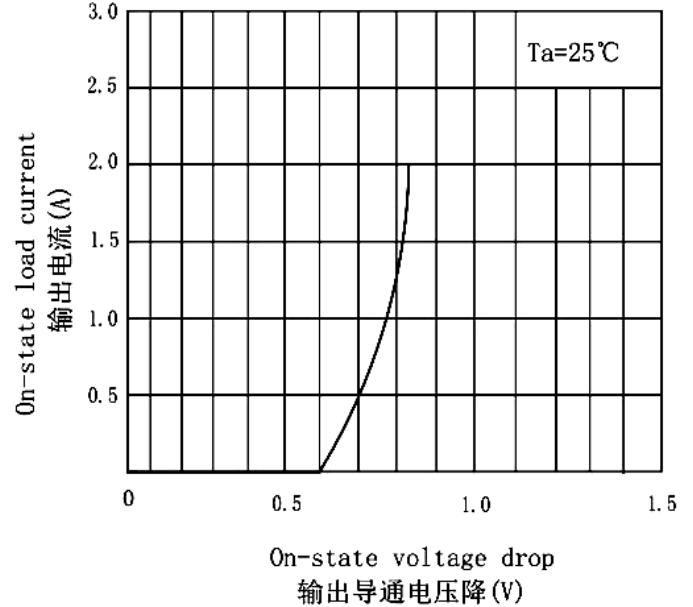

BC5213、BC5223 型光可控硅继电器

On-state R. M. S current Vs. Ambient temperature
输出电流-环境温度曲线

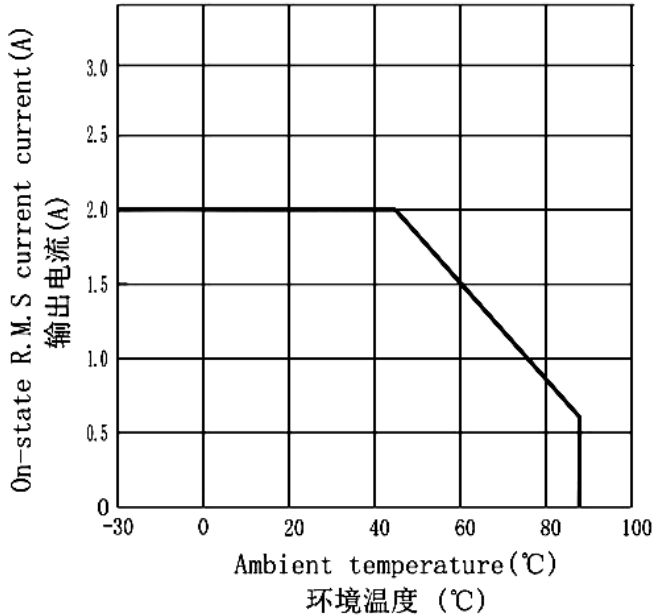

Foward current Vs. Ambient temperature
输入电流-环境温度曲线

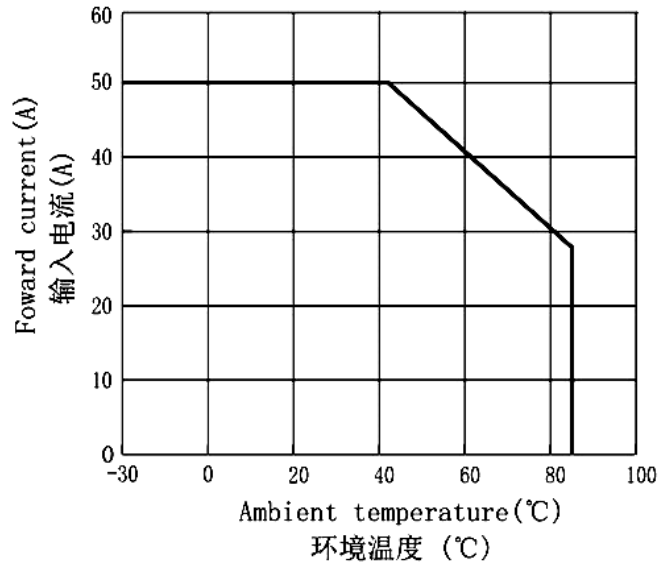

Turn on time Vs. Foward current
导通时间-输入电流曲线

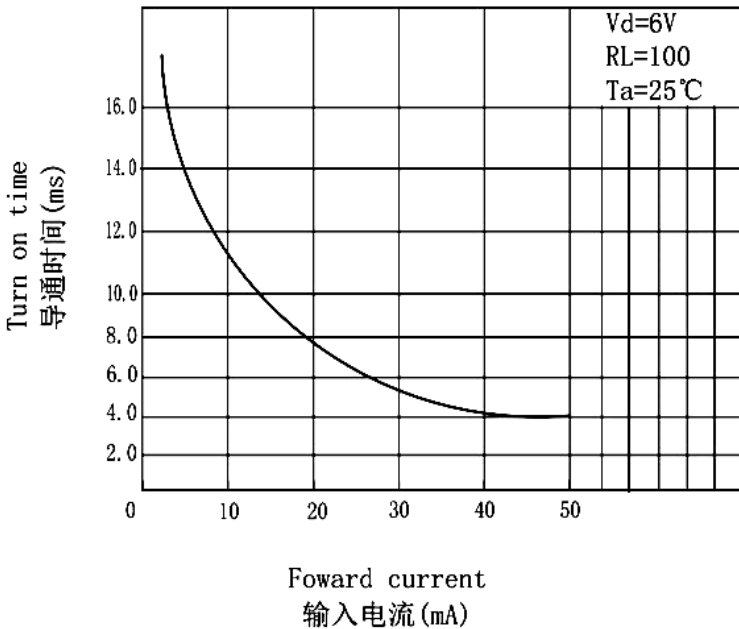

On-state voltage drop VS. Ambient Temperature
输出导通电压降-环境温度曲线

