

BCY215S 型光 MOS 继电器

产品图片	Features 产品特性	Application 应用
 <p>SOP4</p>	<ul style="list-style-type: none"> ● Contact Form 触点形式 1a ● Load Voltage 输出电压 80V ● Load Current 输出电流 1.25A ● Operation LED Current 二极管导通电流 3.0mA ● On-Resistance 导通电阻 0.13Ω ● Output Capacitance 输出电容 220pF ● Low Off-State Leakage Current 漏电流 1.0μA 	<ul style="list-style-type: none"> ● Electric Vehicle 新能源电动汽车 ● Automatic Test Equipment 自动检测设备 ● Security Equipment 安全设备 ● Sensing Equipment 传感设备 ● Telephone Equipment 通信设备 ● I/O Modules I/O 模块 ● Modem 调制解调器

Dimensions 外形尺寸

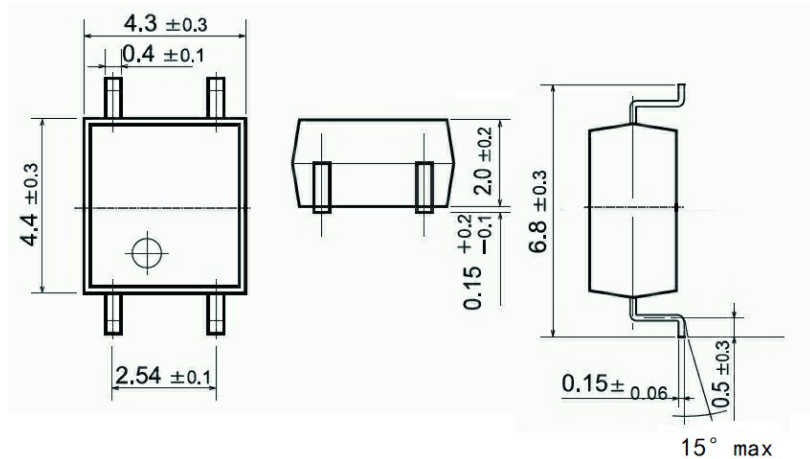

Terminal Identification 引脚标识

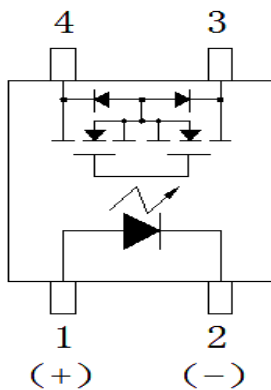

Wiring Diagram 接线图

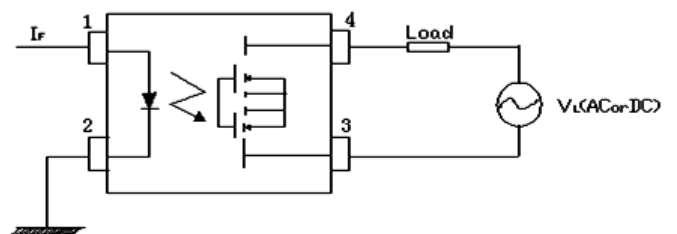



BCY215S 型光 MOS 继电器

Technical parameters 技术参数 (Ambient Temperature 25°C)

I/O Absolute Maximum Ratings 输入输出电气参数最大值

Item 项目		Symbol 符号	Value 数值
Operating Temperature 工作温度		T_{OPR}	-40°C~+85°C
Storage Temperature 储存温度		T_{STG}	-40°C~+100°C
Input 输入	Continuous LED Current 工作电流	I_F	50mA
	Peak LED Current LED 峰值电流 (f=100Hz, Duty=1%)	I_{FP}	500mA
	LED Reverse Voltage 反向电压	V_R	5V
	Input Power Dissipation 输入功耗	P_{IN}	75mW
Output 输出	Load Voltage 输出电压	V_L	80V (AC peak or DC)
	Load Current 输出电流	I_L	1.25A
	Peak Load Current 峰值输出电流 ((1ms, 1 shot)	I_{PEAK}	3A
	Output Power Dissipation 输出功耗	P_{OUT}	350mW
Total Power Dissipation 总功耗		P_T	400mW
I/O Breakdown Voltage 输入输出间隔离电压		$V_{I/O}$	1500Vrms
I/O Breakdown Voltage 输入输出间隔离电压 (加注 H)		$V_{I/O}$	3750Vrms

Electrical Specifications 输入输出电气参数

Item 项目		Symbol 符号	MIN. 最小值	TYP. 典型值	MAX. 最大值	Units 单位	Conditions 条件
Input 输入	LED Forward Voltage 正向电压	V_F	1.0	1.37	1.5	V	$I_F=10mA$
	Operation LED Current 接通电流	$I_{F ON}$		1.0	3.0	mA	
	Recovery LED Voltage 关断电压	$V_{F OFF}$	0.5	1.0		V	
Output 输出	On-Resistance 导通电阻	R_{ON}		0.13	0.16	Ω	$I_F=5mA, I_L=Rating$ within 1sec.
	Off-State Leakage Current 漏电流	I_{LEAK}			1.0	μA	$V_L=80V$
	Output Capacitance 输出端容量	C_{OUT}		220		pF	$V_L=0V, f=1MHz$
Time parameters 时间参数	Turn-On Time 接通时间	T_{ON}		0.4	3.0	ms	$I_F=5mA,$
	Turn-Off Time 关断时间	T_{OFF}		0.05	0.5	ms	$I_L=Rating$
I/O 输入输出	I/O Insulation Resistance 绝缘电阻	$R_{I/O}$	10^9			Ω	
	I/O Capacitance 隔离电容	$C_{I/O}$		1.3		pF	f=1MHz

通讯地址: 深圳市宝安区外贸工业园 6 栋 3 楼

联系人: 蒋生

电 话: 13554924172



Reference Data 曲线图

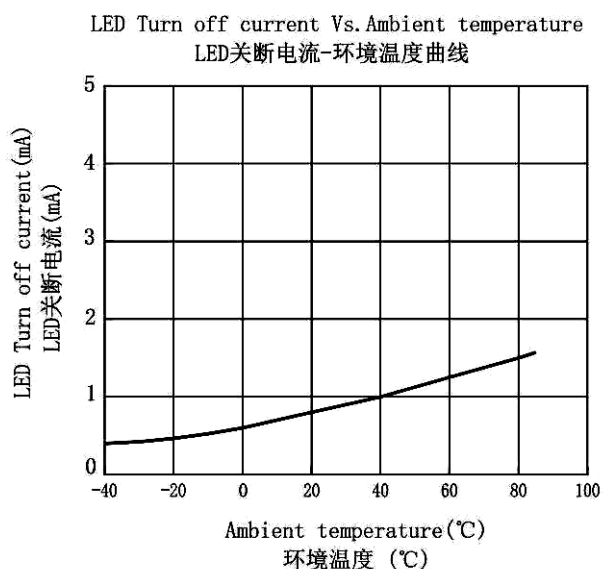
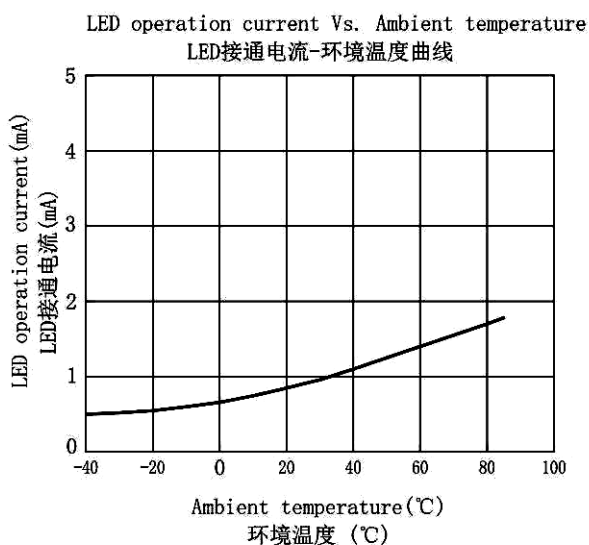
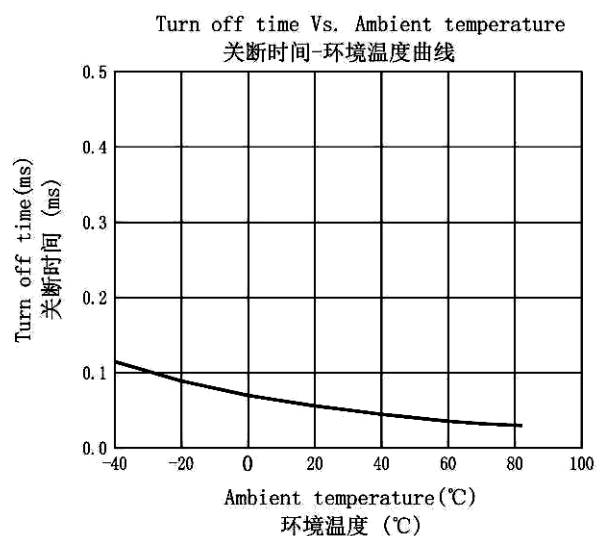
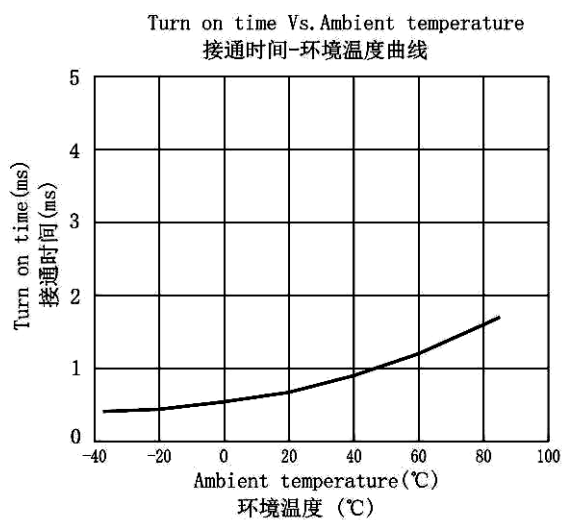
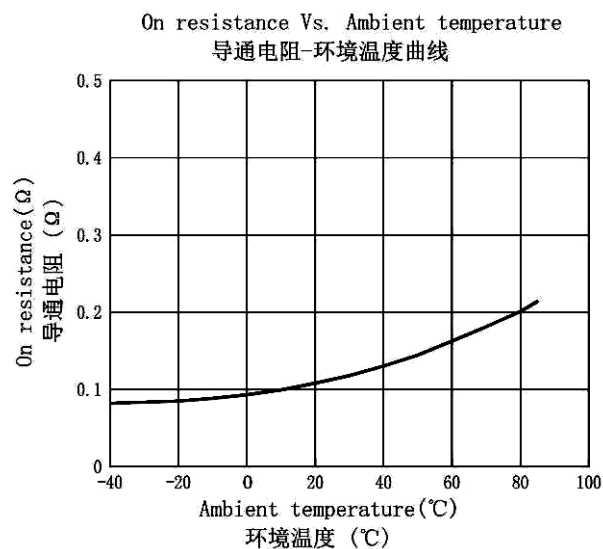
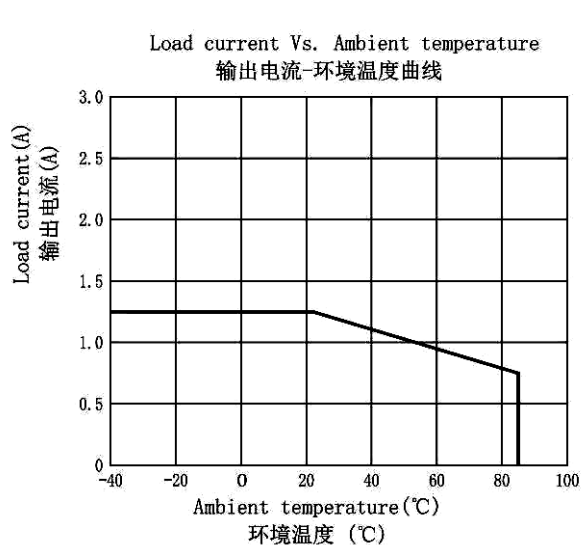



BCY215S 型光 MOS 继电器

LED forward voltage Vs. Ambient temperature
LED正向电压-环境温度曲线

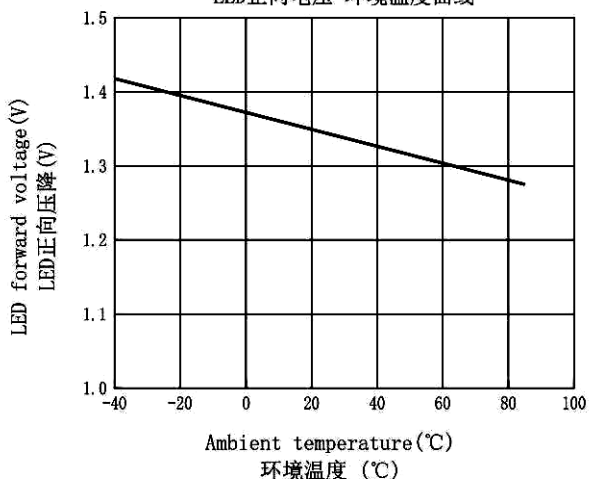

Voltage Vs. current characteristics of output at MOS portion
MOS管输出电压-输出电流曲线

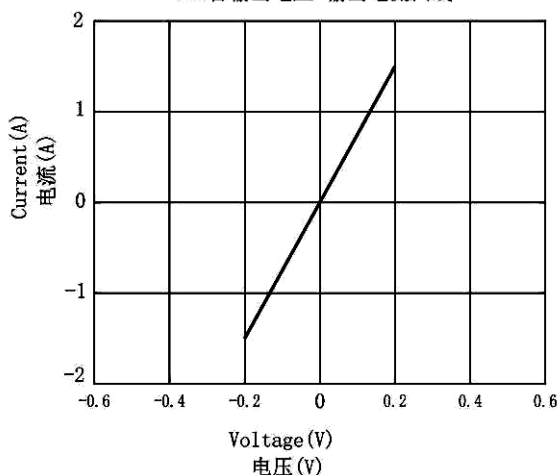

Off state leakage current Vs. Load voltage characteristics
输出漏电流-输出电压曲线

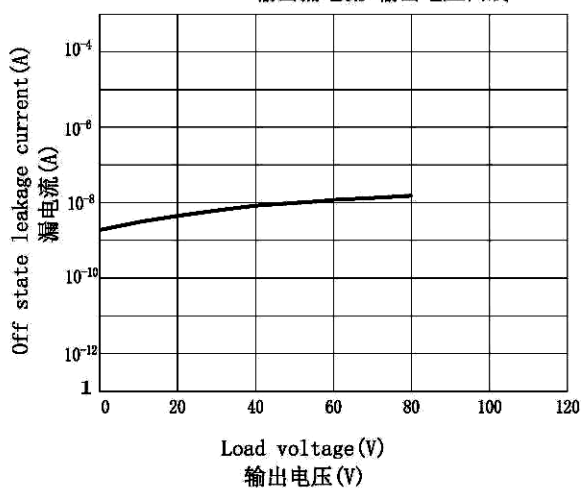

LED forward current Vs. turn on time characteristics
LED工作(正向)电流-导通时间曲线

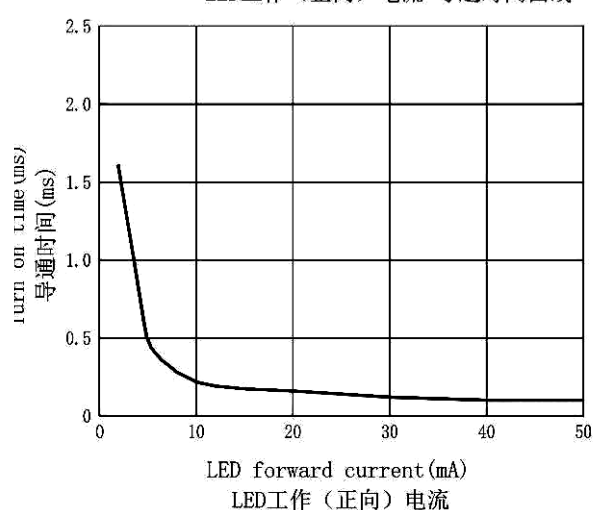

LED forward current Vs. Turn off time characteristics
LED工作(正向)电流-关断时间曲线

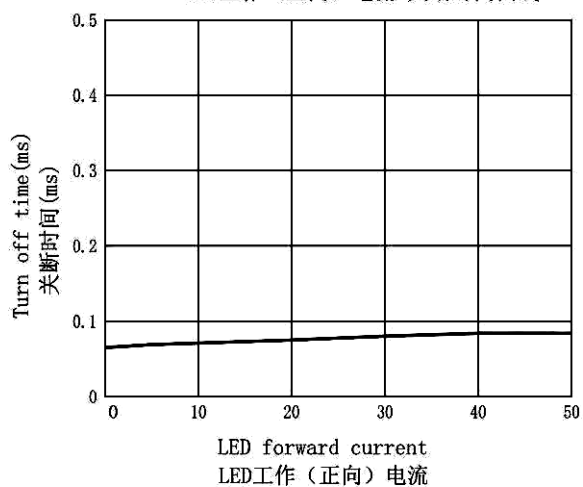

Applied voltage Vs. output capacitance characteristics
输出电压-输出电容量曲线

